

**TELAIRE®**

# SMART Sensor

Application Notes

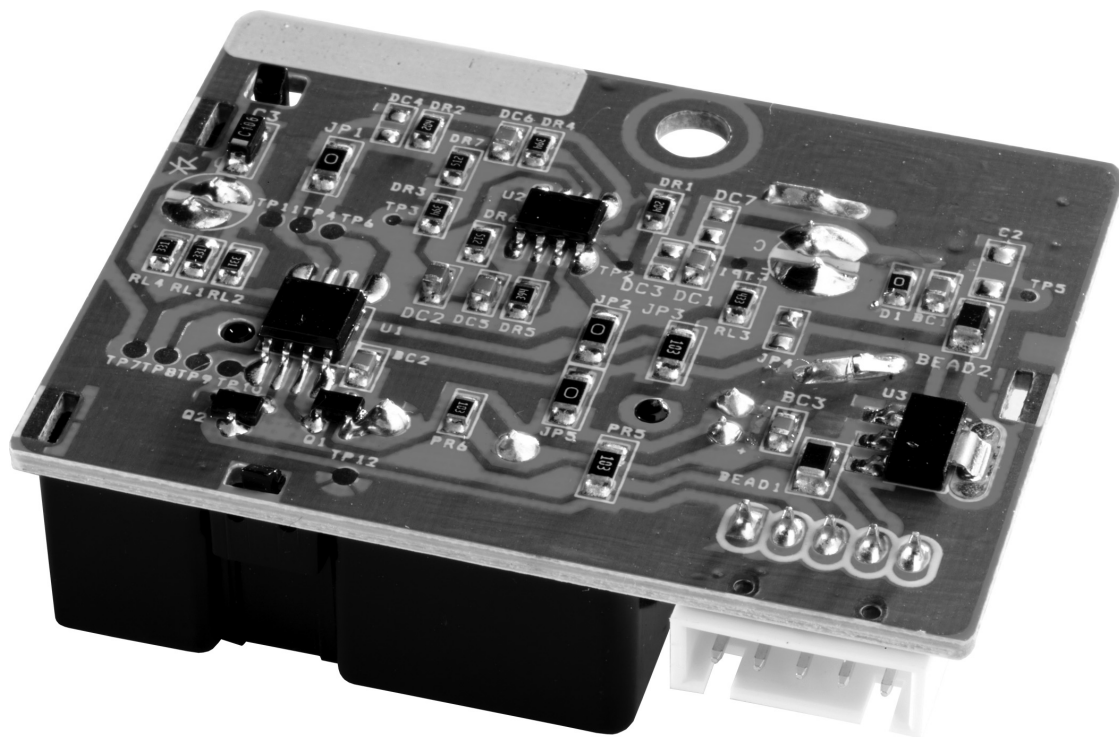

**Amphenol**  
Advanced Sensors

AAS-916-134 Rev. A  
August 2014



# Table of Contents

1. Description . . . . .	1
2. Features . . . . .	1
3. Applications . . . . .	2
4. Internal Schematic . . . . .	2
5. Electrical Characteristics . . . . .	2
6. Connector . . . . .	3
7. Pin Configuration . . . . .	4
8. Electro-Optical Characteristics . . . . .	4-5
9. Distinguishing between Cigarette Smoke and Large House Dust Particles . . . . .	6
10. Low Pulse Width vs. Dust Size Distribution . . . . .	7
11. Application Notes . . . . .	7-9
12 Reliability . . . . .	10
13. Test Standard for Dust Sensor Calibration . . . . .	11
14. Lot Control . . . . .	11
15. Packing Specifications . . . . .	12
16. Outline Dimensions . . . . .	13
17. Document Revision History . . . . .	14



---

# SM-PWM-01A

## SMART dust sensor for air purifier

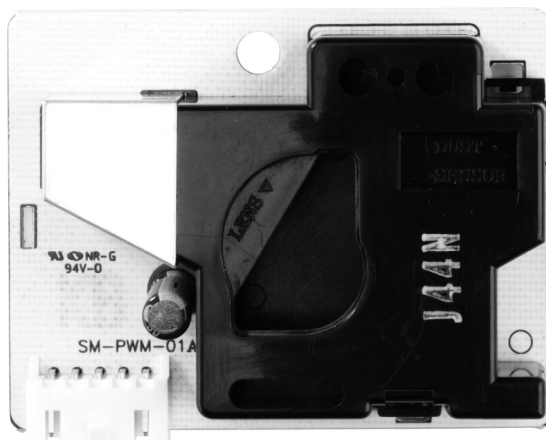

### 1. Description

SM-PWM-01A dust sensor detects dust particle concentration in air by using an optical sensing method. An infrared light emitting diode (IR LED) and a photo-sensor are optically arranged in the device. The photo-sensor detects the reflected IR LED light by dust particles in air. The dust sensor can detect the small particles like cigarette smoke and can distinguish small particles like smoke from large house dust by the pulse pattern of the signal output.

### 2. Features

- Compact size, light weight (about W59x H46x D18 mm, 23g).
- PWM (pulse width modulation) output (Low pulse output).
- Distinguishes small particles of cigarette smoke from large particles of house dust.
- The Low pulse width is proportion to particle size and concentration.
- Constant forced air convection flow by heater resistor in dust sensor.
- Lead free and ROHS directive compliant .
- Minimum particle size can be detected over 1 $\mu$ m (House dust size: avg 20 $\mu$ m, yellow dust size: avg 20 $\mu$ m, cigarette dust size: avg 1 $\mu$ m).

### 3. Applications

- Detection of dust in the air for Indoor Air quality monitoring.
- Air cleaners, Air purifiers, Air conditioners and Indoor Air Quality monitors.
- Outdoor dust monitoring with the special mechanical design for customer.
- Smoke type fire alarm application by different sensor adjustments (customer option)

### 4. Internal Schematic

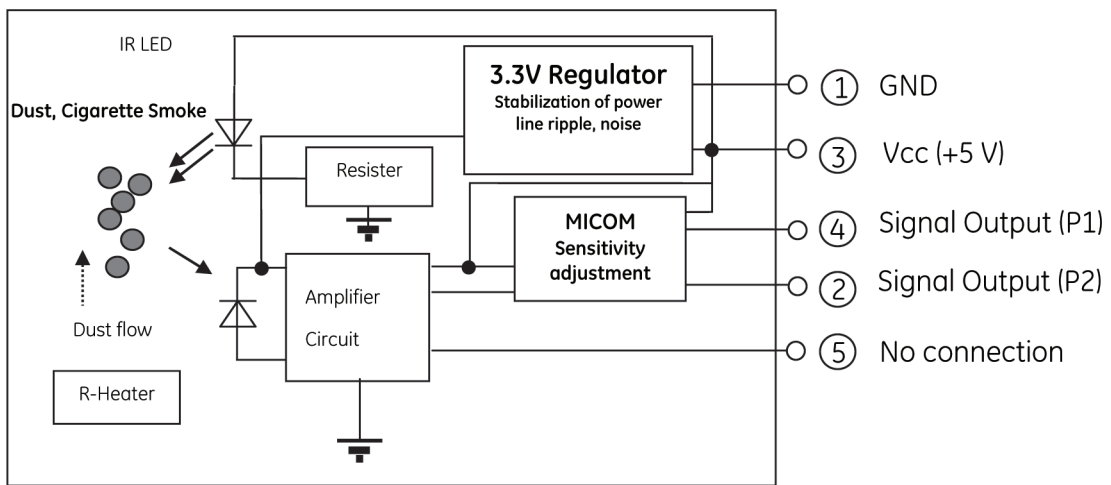

P1: small particle (1 ~ 2 $\mu$ m), P2: large particle (3 ~ 10 $\mu$ m)

- SM-PWM-01A dust sensor can't count particles, measure quantitatively; the size is only for reference.

### 5. Electrical Characteristics

#### 5.1 Absolute Maximum Ratings

Parameter	Symbol	Rating	Unit
Supply voltage	Vcc	-0.3 to + 7.0	V
Operating temperature	Topr	-10 to 60	°C
Storage temperature	Tstg	-30 to 80	°C

## 5.2 Operating Supply Voltage and Signal Output

(Ta=25 °C)

Parameter	Symbol	Rating	Unit
Supply voltage	Vcc	DC 5 ± 5%, Ripple <100mV	V
Current Consumption	Icc	< 100± 5%	mA
Signal output	P1,P2	Hi : > 4.5V, Lo : <0.7V, *1 Negative Logic Pulse output	
Power up time *		90 *2	Sec

\*1. Input impedance 200 kΩ Pull-Up 10 kΩ, recommend 30 sec moving average of output signal

\*2. To stabilize heater resistor and air flow in dust sensor.

## 5.3 Recommend Operating Temperature/Humidity

Parameter	Rating	Unit
Operating Temp./Humidity	-10 ~ 45°C, < 85%RH *1	°C, %RH

\*1. Dust sensor can detect the micro size water droplet, like fog and mist, as particles.

Do not use the dust sensor in high humidity environments as the humid air is under submicron size and the dust sensor cannot differentiate this.

## 6. Connector

Standard connector (SM-PWM-01A)

ConnectorPartNo.	Symbol	Description	Maker
Connector	SMAW250-05G	2.5mm pitch	YeonHo Elec.(Korea) <a href="http://www.yeonho.com/">http://www.yeonho.com/</a>
Housing	25048HS-05		
Terminal	YST025		

- SMAW250-05G is standard.

## 7. Pin Configuration

Number	Symbol	Pin Description
1	GND	Ground, Connect with System ground
2	P2	Low pulse Signal output(P2) of large particle, active low
3	Vcc	Input Supply voltage
4	P1	Low pulse Signal output(P1) of small particle, active low
5	NC	no connected,

Please refer to the drawing for pin sequence.

- For P1 and P2, Do not need to external pull up resistor, internal pull up resistor is 10K.

## 8. Electro-Optical Characteristics

Parameter	Symbol	Condition	Min	Typ	Max	Unit
Sensitivity	S	*1*2*5	1.1	1.5	1.7	%/100,000(count / ft <sup>3</sup> )
Low pulse output occupancy	LPO (typical)	*3*4	0	1.3	11.5	%
Detection range	M	*4	50,000	100,000	800,000	count / ft <sup>3</sup>

\*1. Sensitivity is specified by the amount of low pulse occupancy change when dust concentration changes from 100,000 count /Ft<sup>3</sup> to 400,000count/ft<sup>3</sup> theoretically. The 120 second is needed for the stabilization of dust sensor in the testing chamber.

\*2. Sensitivity of dust sensor is shown in Fig.1

\*3. Low pulse occupancy (%) = total sum of low pulse width (mSec)/30,000mSec\*100.

Low pulse output is measured from the output signal of P1, connector pin number 4 in dust sensor. Moving average calculation method during certain measuring time (Top) is used to determine the contaminated level of air. LPO is depended on the dust concentration and dust size and it changes from 0 to 20%. (Refer Fig.1)

\*4. Dust concentration: Normally cigarette smoke's particle size distributes from 0.3 to 10 micrometer. The particle size of one micrometer of cigarette smoke is monitored in our test chamber for the calibration test of dust sensor.

\*5. The Particle size and concentration is measured using LD3, GT331 made by Shibata japan and METONE USA. Linearity of SM-PWM-01A sensitivity will be kept up to15 percent occupancy.



**Fig.1 Signal output(P1) Characteristics for Cigarette Smoke**

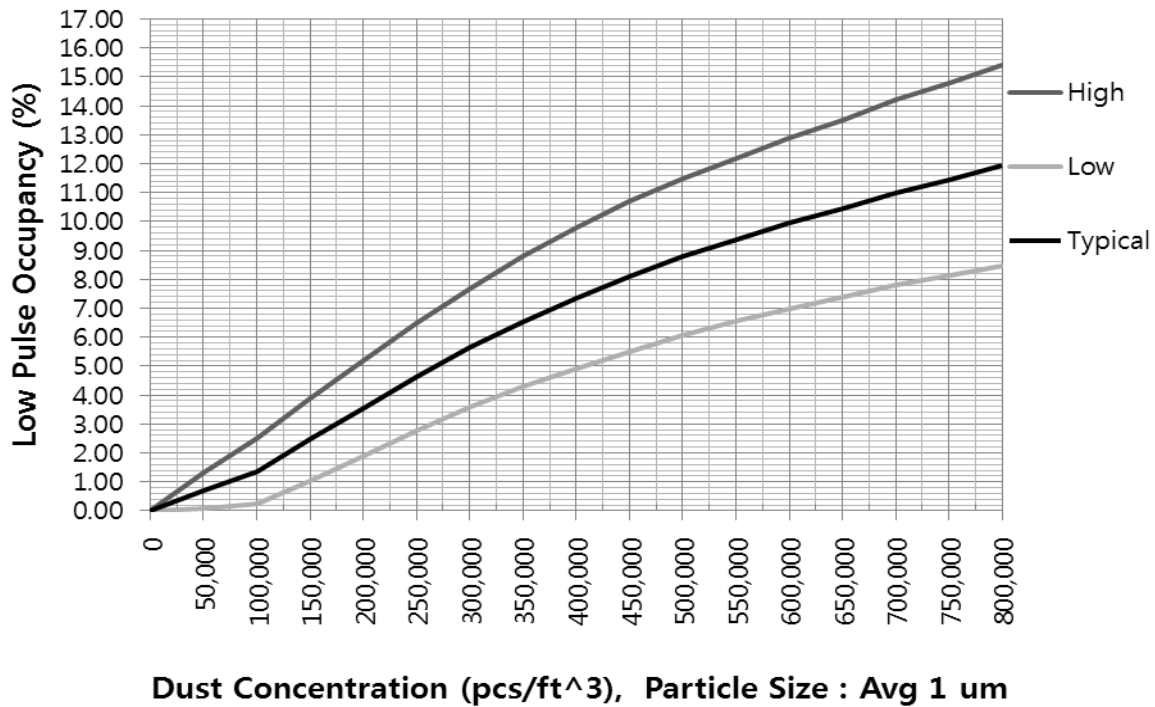

- The sensor is tested at dust concentration of 400,000 and 100,000 pcs/ft<sup>3</sup> for sensitivity adjustment.
  - LPO range of high and low sample are from 9.80 % to 4.89% at 400,000.pcs/ft<sup>3</sup> dust concentration.
  - LPO range of high and low sample are from 2.50% to 0.24% at 100,000pcs/ft<sup>3</sup> dust concentration.
  
- Guide line to display and motor control method by the contamination level
  - Level 1: Normal house and office's contamination level is 50,000 pcs per cubic feet.
  - Level 2: If cigarette smoke is started to contaminate the room, LPO is increase and soon reach from 1.5 ~ 2 %
  - Level 3: If dust or cigarette smoke contaminates the room more, LPO is increased continuously up 3~4%.
  - Level 4: If dust or cigarette smoke is at a high concentration and LPO level reaches up to 6%, please monitor LPO level change over 30 seconds and compare the LPO level by moving average statistical method. Guideline only.

## 9. Distinguishing Method between small cigarette smoke and large house dust

As shown in Figure 2 below, the output of small cigarette smoke shows narrow pulse or overlapped pulse shape continuously. The output of large dust shows wide pulse and not overlapped.

Therefore, by reading a transition of output pulse during a certain time period using system MICOM, the system can distinguish:

- (a) Type of dust
- (b) Large particle
- (c) Small particle

Fig. 2

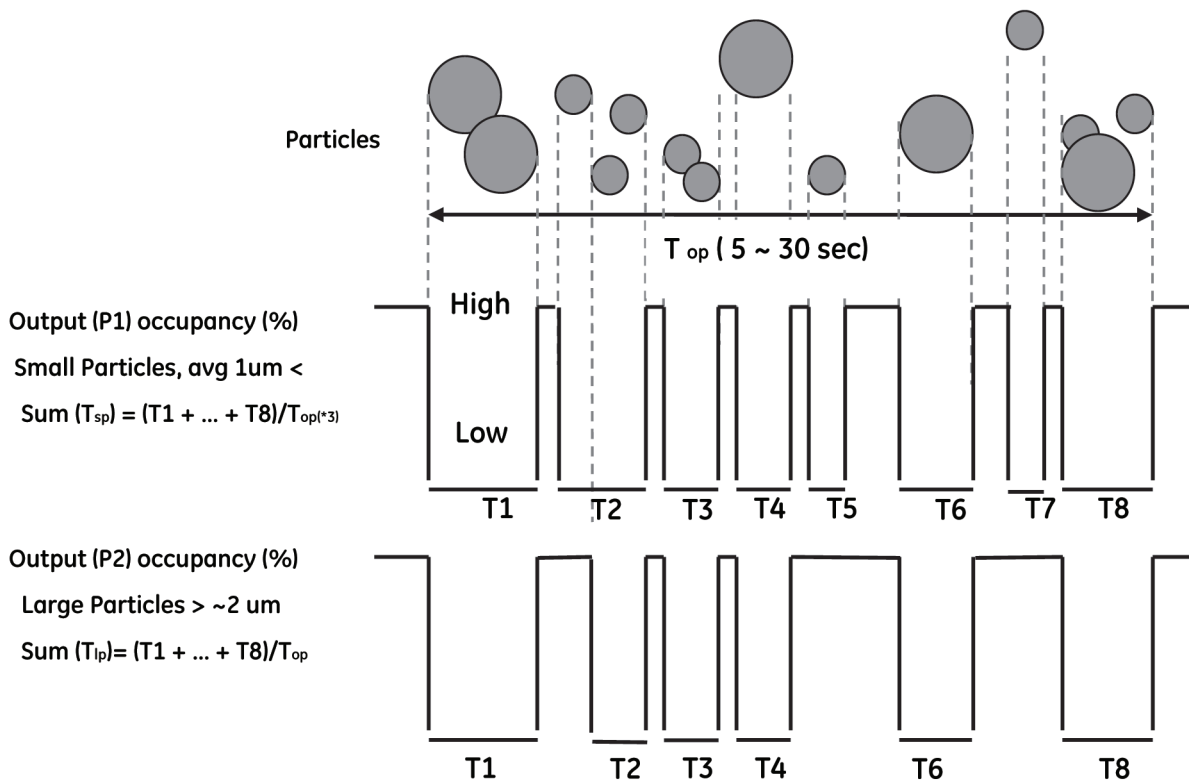

---

## 10. Low pulse width vs. Dust size distribution

Parameter	Symbol	Conditions	Min	Typ	Max	Unit
Low pulse width of a small particle (P1)	T <sub>sp</sub>	*1 Cigarette smoke		100		mSec
Low pulse width of a large particle(P2)	T <sub>lp</sub>	*2 House dust		100		mSec

\*1. Low pulse width is decided by dust size and concentration. In a moderately contaminated condition, 100,000 count/ft<sup>3</sup> of cigarette smoke, output pulse width of P1 pin is the average detection result of average one micrometer size of particles based on cigarette smoke during certain period.

\*2. Low pulse width of a big house dust particles is bigger than cigarette smoke particles. The particle size is normally 5 to 20 $\mu$ m and more. P2 can be used to detect large particle like house dust and pollen.

\*3. Top is the continuous operating time for particle detection. It is normally from 5 to 10 second for air cleaner application for fast feeling.

## 11. Application Notes

### 11.1 EMI and Power Line Noise Protection and Malfunction

The plastic cover case is conductive polymer material or has same function by treatment. Top metal shield case and plastic cover case is connected with GND in sensor. The photo sensor signal is weak for EMI. To protect EMI affection of photo sensor signal from motor and high voltage source, an additional bottom metal shield case could be soldered on electronic PCB's ground by customer requirements. Normally, top shield case is enough to protect EMI from outer electronic goods. However, to prevent EMI from high voltage negative ion generator and power line noise from electric dust collector, please install the high voltage generator in the opposite side from dust sensor - also pay attention to prevent power line noise by using noise filter. The malfunction of dust sensor can be observed by taping all holes of dust sensor completely not to penetrate dust into open holes of dust sensor. After making clean the dust sensor chamber and taping all holes not to come any dusts into optical zone of sensor and operate the sensor. In this experiment dust sensor has not to show any low pulse output. If it is interrupted by EMI and line noise, many Low pulse output signal will be showed up. In this case, please consult Amphenol Advanced Sensors technical team.

## 11.2 Dust Sensor Install Method

When installing the dust sensor in air cleaner, dust sensor must be installed vertically in a place that is not affected by air flow caused by motor fan rotation. We recommend to install dust sensor in the front panel. The dust sensor can detect the water vapor as dust. Please do not use dust sensor in a vaporizing place like a bathroom or near a air humidifier. Dust sensors use IR wave-length LED and the visible cutoff photo sensor, but the irradiation by lamp light of optical zone will cause malfunction of dust sensor. Please cover the center hole shaped triangle by using black sponge not to irradiate dust sensor optics. Please do not cover the bottom and top hole for air flow to measure the dust. The center hole of PCB is for screwing bolt to system. Please use screw PH 3 pie for fixing. Please pay attention not to damage and touch sensor case.

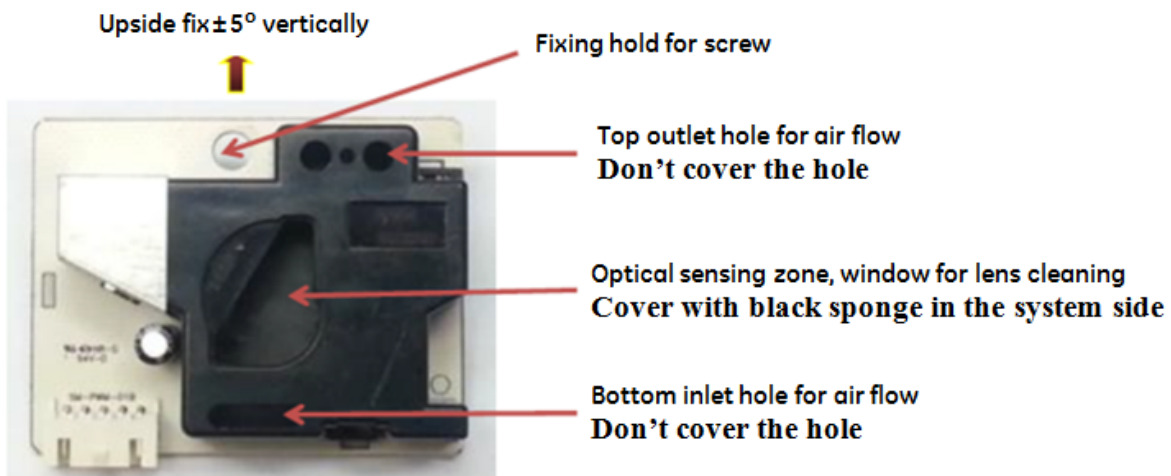

The heater resistor is installed inside of dust sensor for inducing the forced air convection and the heated air flows from bottom side to top side direction. The heater resistor's temperature is increased over  $40^\circ\text{C}$  than atmosphere. So, vertical positioning of dust sensor is important for air flow direction and speed optical zone. The air flow direction and flow speed can affect the signal output of dust sensor. Please keep  $\pm 5$  degree position vertically.

## 11.3 Cleaning

Cigarette tar on the lens will not affect the sensitivity of the dust sensor. Wet swab with alcohol and rub softly the lens and dry. Normally wet cleaning is not recommended, because there is a case this device is not satisfied with its characteristics by wet cleaning. Wet cleaning is not recommended, and may not improve characteristics. If large particles such as home dust are accumulate in the dust sensor optics parts, please consider vacuuming or blowing off the dust by air.

---

#### 11.4 **Sensitivity Adjustment, Customized Low Pulse Output Data Control by MICOM Programming**

SM-PWM-01A is the dust sensor that sensitivity is adjusted by MICOM program. Customer cannot change the sensitivity by changing volume resistor. MICOM send the low pulse output data proportional with dust concentration. Also MICOM can be programmed to send the communication code with system MICOM like code for LED level or code for monitoring sensor life. If customer wants to use dust sensor to special purpose like fire detection, MICOM program can be changed to send low pulse data for fire alarm level warning. Please contact your Amphenol Advanced Sensors technical team for more information.

#### 11.5 **Responsibility**

This product shall not contain the following materials banned in RoHS Directive. (2002/95/EC)  
Pb, Hg, Cd, Cr+6, PBB, PBDE

---

Amphenol Advanced Sensors takes no responsibility for any problems related to any intellectual property right of a third party resulting from the use of Amphenol Advanced Sensors' device. Amphenol Advanced Sensors takes no responsibility for damage caused by improper use of the device which does not meet the condition of absolute maximum ratings to be specified in relevant specification sheet nor meet the condition of the extremely high level of reliability and safety such as safety device, clean room monitoring, fire alarm, life support equipment, etc.

This publication is the proprietary product of Amphenol Advanced Sensors and is copyright with all rights reserved. Under the copyright laws, no part of this publication may be reproduced or transmitted in any form of or by any means, for any purpose, without the express written permission of Amphenol Advanced Sensors. The express written permission is also needed before any use of this publication by a third party.

Please contact with a Amphenol Advanced Sensors representative if there are any questions for this publication.

## 12. Reliability

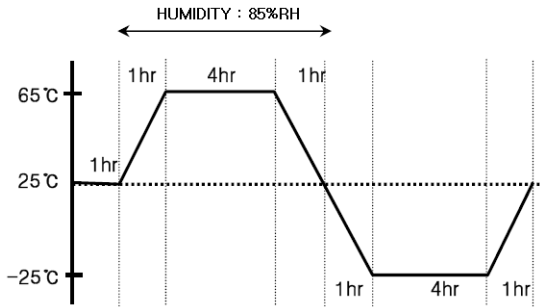
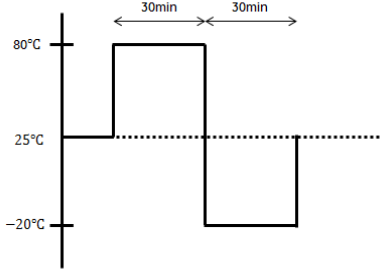
1	Drop	Drop it unintentionally from 100cm height down to the hard wooden board three times at random direction	<ul style="list-style-type: none"> <li>- No damage,</li> <li>- No breakage,</li> <li>- Output Within <math>\pm 30\%</math> of the initial LPO of sample)</li> </ul>	N=10
2	High temp. Storage	Leave in the atmosphere 80°C for 1,000 hours		
3	Low temp. storage	Leave in the atmosphere -30°C for 1,000 hour		
4	Thermal Cycle	Repeat 20 times in the following cycle. 		
5	Thermal Shock	Repeat 20 times in the following cycle. 		
6	High Temp. Operation	Operating it in the atmosphere of 60°C for 1000 hours		
7	Low Temp. Operation	Operating it in the atmosphere of -10°C for 1000 hours		
8	Mechanical shock	Frequency : 5~55~5Hz Acceleration : 21.6m/s <sup>2</sup> (2.2G) Direction : X,Y,Z direction for 2 hours		

### 13. Test Standard for dust sensor calibration

The first standard is the certificated particle counter.

The second standard is the master dust sensor. The master dust sensor is always used for the process quality control of production.

The master dust sensor will be compared with the customer master sensor every six months.

### 14. Lot control

Lot number: Four digit stamping of the manufacturing date on dust sensor PCB side.

Year		Month		Day				Day/Night time		
E	2009 Y	1	1 M	1	1 D	G	16 D	D	Day time	Day time : 09 ~ 18
F	2010 Y	2	2 M	2	2 D	H	17 D			
G	2011 Y	3	3 M	3	3 D	I	18 D	N	Night time	Night time : After 18
H	2012 Y	4	4 M	4	4 D	J	19 D			
I	2013 Y	5	5 M	5	5 D	K	20 D			
J	2014 Y	6	6 M	6	6 D	L	21 D			
K	2015 Y	7	7 M	7	7 D	M	22 D			
L	2016 Y	8	8 M	8	8 D	N	23 D			
M	2017 Y	9	9 M	9	9 D	O	24 D			
N	2018 Y	A	10 M	A	10 D	P	25 D			
O	2019 Y	B	11 M	B	11 D	Q	26 D			
P	2020 Y	C	12 M	C	12 D	R	27 D			
Q	2021 Y			D	13 D	S	28 D			
R	2022 Y			E	14 D	T	29 D			
S	2023 Y			F	15 D	U	30 D			
T	2024 Y					V	31 D			
U	2025 Y									

**Example**  

L/N : IASD
------------

 => 2013 year, 10 month, 28 day, day time,

## 15. Packaging Specification

WEIGHT: max 12kg

	L1	L2	H	Inner Qty.	Total Qty.
Box 1 (Large)	395 mm	395 mm	410 mm	8	400
Box 2 (Small)	395 mm	395 mm	265 mm	4	200

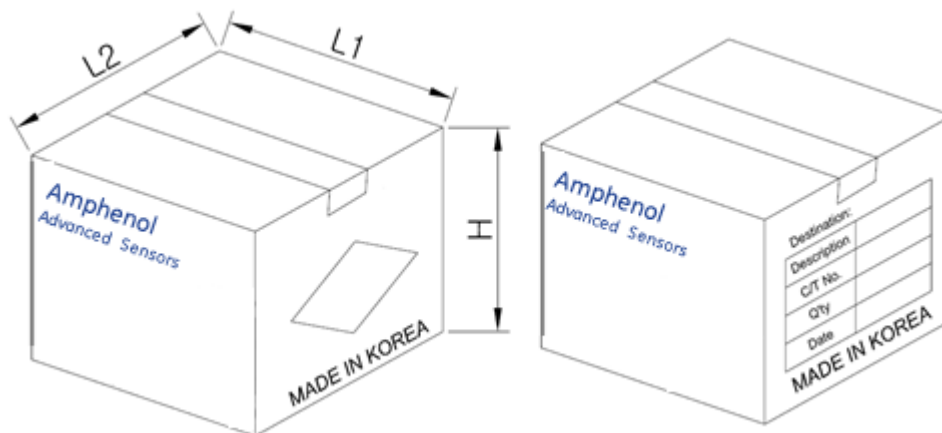



## 16. Outline Dimension

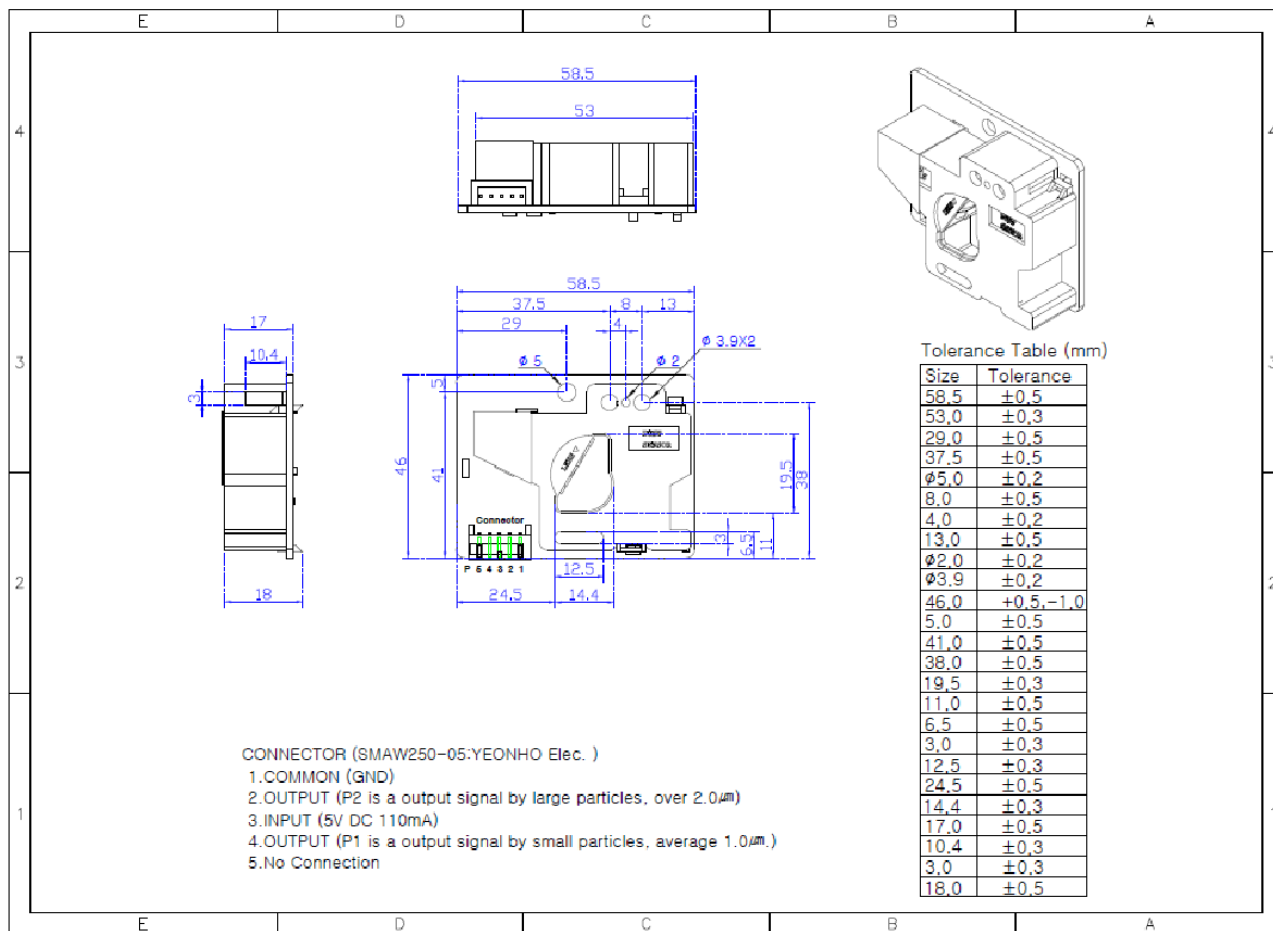

---

## 17. Document Revision History

No.	Section and description of revision:	Date	Author
0.0	Initial Release	2013.10.30	Hoon. Hur
1.0	Change Doc. format	2013.11.15	Hoon, Hur
1.1	Change <ul style="list-style-type: none"><li>- the company name to Amphenol</li><li>- Part number</li><li>- Front view dust sensor</li><li>- Packaging information</li></ul>	2014.06.30	Hoon, Hur



# Customer Support Centers

## **U.S.A.**

### **Sales and Services**

#### **(Repair/Calibration):**

Amphenol Thermometrics, Inc.  
St Marys Center  
967 Windfall Road  
St Marys, Pennsylvania 15857  
U.S.A.  
T: 814-834-9140  
F: 814-781-7969

## **Europe, Asia and Middle East**

### **Sales and Service:**

Amphenol Advanced Sensors GmbH  
Sinsheimer Strasse 6  
D-75179 Pforzheim  
Germany  
T: +49(0)7231-14335 0  
F: +49(0)7212 391 035

## **Brazil**

### **Sales and Service**

Amphenol TFC DO Brazil LTDA  
Rodovia Governador Adhemar  
Pereira de Barros KM 121,5 S/N  
13098-396 Campinas  
Sao Paulo, Brazil

## **U.S.A.**

### **Technical Support:**

Amphenol Thermometrics, Inc.  
St Marys Center  
967 Windfall Road  
St Marys, Pennsylvania 15857  
U.S.A.  
T: 814-834-9140  
F: 814-781-7969

## **China:**

Amphenol (Changzhou)  
Connector Systems  
305 Room, 5D  
Jintong Industrial Park  
Wujin, Changzhou, Jiangsu, China  
T:+86 519 8831 8080 ext. 50087  
F:+86 519 8831 2601

# **Amphenol**

## **Advanced Sensors**

[www.amphenol-sensors.com](http://www.amphenol-sensors.com)

©2014 Amphenol Thermometrics, Inc. All rights reserved.  
Technical content subject to change without notice.